

Zeitplan EWU-Turnier: C Giekau

Veranstaltungstag: **Samstag, 03.05.2014**

Beginn Prüfung	Prüfungsbezeichnung	Dauer	Ende	Starts	Pattern
07:30	Öffnung Meldestelle	01:00	08:30		
08:30	LK 4/5 A SSH Showmanship at Halter	00:20	08:50	7	
08:50	LK 4B SSH Showmanship at Halter	00:15	09:05	3	
09:05	LK 3B SSH Showmanship at Halter	00:15	09:20	3	
09:20	LK 3A SSH Showmanship at Halter	00:20	09:40	7	
09:40	Sonderprüfung Walk Trot Showmanship	00:10	09:50	2	
09:50	LK 1/2 B WHS Western Horsemanship	00:15	10:05	5	
10:05	LK 2A WHS Western Horsemanship	00:20	10:25	7	
10:25	LK 1A WHS Western Horsemanship	00:20	10:45	6	
10:45	LK 3B WPL Western Pleasure	00:15	11:00	5	
11:00	LK 3A WPL Western Pleasure	00:25	11:25	10	
11:25	LK 4B WHS Western Horsemanship	00:15	11:40	4	
11:40	LK 4A WHS Western Horsemanship	00:35	12:15	15	
12:15	Pause	00:30	12:45		
12:45	LK 5B TH Trail	00:15	13:00	2	
13:00	LK 5A TH Trail	00:20	13:20	4	
13:20	Walk Trot WPL Walk Trot Western Pleasure	00:15	13:35	3	
13:35	Walk Trot WHS Walk Trot Western Horsemanship	00:10		2	
anschl. Sonderprüfung	WC Rookie Working Cowhorse	00:15		2	
anschl. Sonderprüfung	WC Open Working Cowhorse	00:15		2	
anschl. Sonderprüfung	CU Rookie Cutting	01:05		6	
anschl. Sonderprüfung	CU Open Cutting	00:30		5	
anschl. Sonderprüfung	Team Penning	00:20		3	
anschl. LK 1/2 B WPL	Western Pleasure	00:15		5	
anschl. LK 2A WPL	Western Pleasure	00:20		7	
anschl. LK 1A WPL	Western Pleasure	00:15		5	
anschl. LK 4 RN	Reining	00:50		9	
anschl. LK 3B WHS	Western Horsemanship	00:15		5	
anschl. LK 3A WHS	Western Horsemanship	00:30		12	

Veranstaltungstag: **Sonntag, 04.05.2014**

Beginn Prüfung	Prüfungsbezeichnung	Dauer	Ende	Starts	Pattern
07:00	Öffnung Meldestelle	01:00	08:00		
08:00	LK 1/2 B SSH Showmanship at Halter	00:15	08:15	3	
08:15	LK 1/2 A SSH Showmanship at Halter	00:20	08:35	6	
08:35	LK 4A TH Trail	00:35	09:10	10	
09:10	LK 3B TH Trail	00:15	09:25	3	
09:25	LK 3A TH Trail	00:45	10:10	13	
10:10	LK 1/2 B TH Trail	00:25	10:35	6	
10:35	LK 1/2 A TH Trail	00:40	11:15	11	
11:15	LK 5B WHS Western Horsemanship	00:15	11:30	4	
11:30	LK 5A WHS Western Horsemanship	00:20	11:50	6	
11:50	Pause	00:30	12:20		
12:20	Sonderprüfung Ranch Horse Pleasure # Richter: Alex Tuzakow #	00:30		13	
anschl. LK 5B WPL	Western Pleasure	00:15		4	
anschl. LK 5A WPL	Western Pleasure	00:20		6	
anschl. LK 4B WPL	Western Pleasure	00:15		4	
anschl. LK 4A WPL	Western Pleasure	00:30		12	
anschl. Sonderprüfung	Galloway Star Ranch Jackpot Reining	00:35		6	
anschl. LK 1/2 B RN	Reining	00:20		3	
anschl. LK 2A RN	Reining	00:45		8	
anschl. LK 1A RN	Reining	00:25		4	
anschl. LK 3B RN	Reining	00:25		4	
anschl. LK 3A RN	Reining	00:45		9	
anschl. LK 3 WR	Western Riding	00:10		1	

Pattern Giekau 2014

RN	LK4 A/B	# 8A
	LK3 A/B	# 2 (A)
	LK2/1 A/B	# 6
	Jackpot	# 11
WCH	Open	# 10
	Rookie	# 3
WR	LK3 A/B	# 6
	LK2/1 A/B	# 3
SUHO	LK2/1 A/B	# 3



Giekau

03./04.05.2014

Showmanship at Halter LK 4/5 u. WT SSH

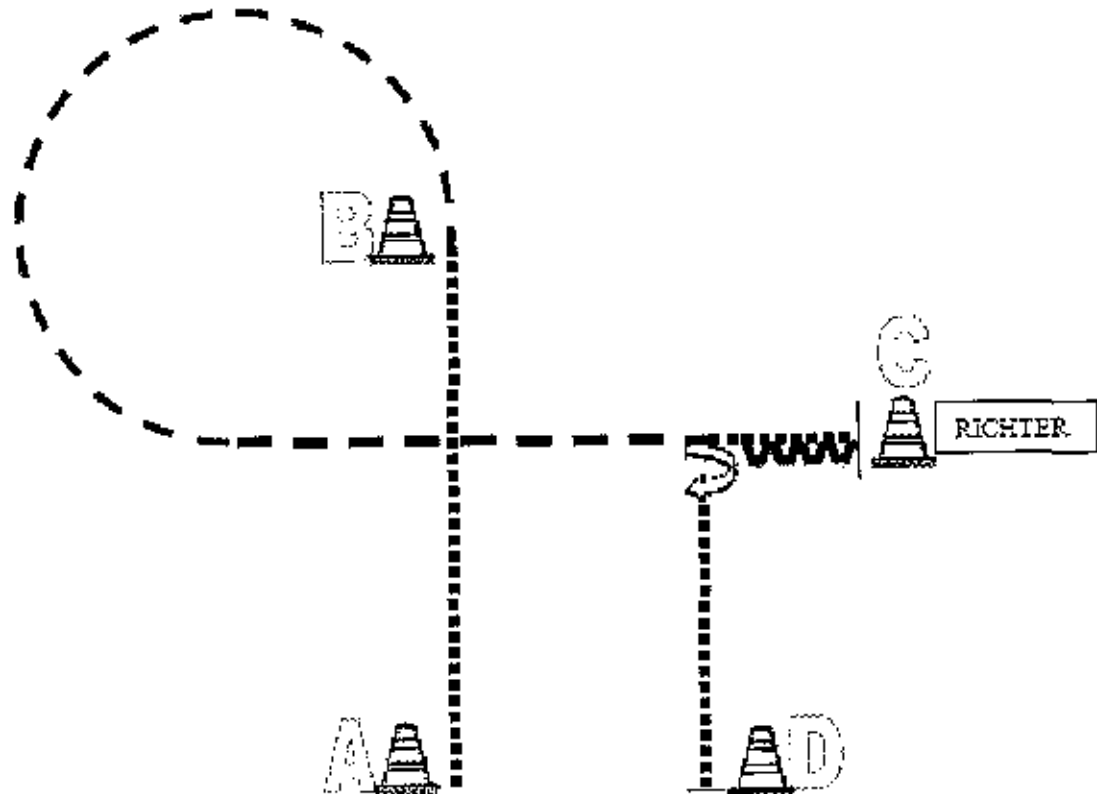

Von A bis B im Schritt
Bei B Trab
3/4 Volte links um B
Vor C Schritt
Bei C anhalten und Set Up von dem Richter
Nach dem Set Up rückwärtsrichten
90° HHW rechts
Schritt zu D, bei D anhalten.

	Back Up
	Walk
	Jog
	Lope
	Wechsel



Giekau
03./04.05.2014

Showmanship LK 3 A/B

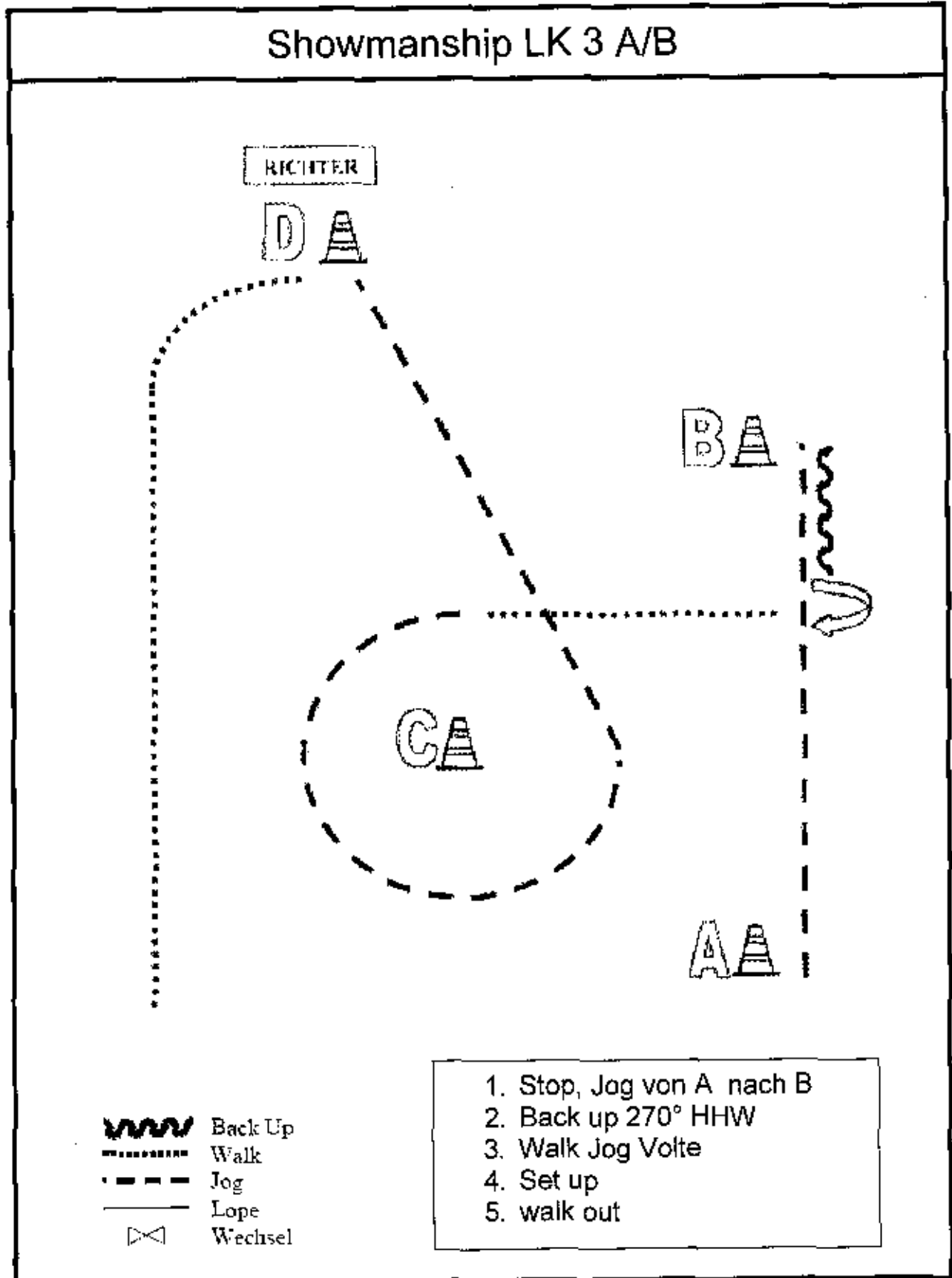

-  Back Up
-  Walk
-  Jog
-  Lope
-  Wechsel





1. Stop, Jog von A nach B
2. Back up 270° HHW
3. Walk Jog Volte
4. Set up
5. walk out

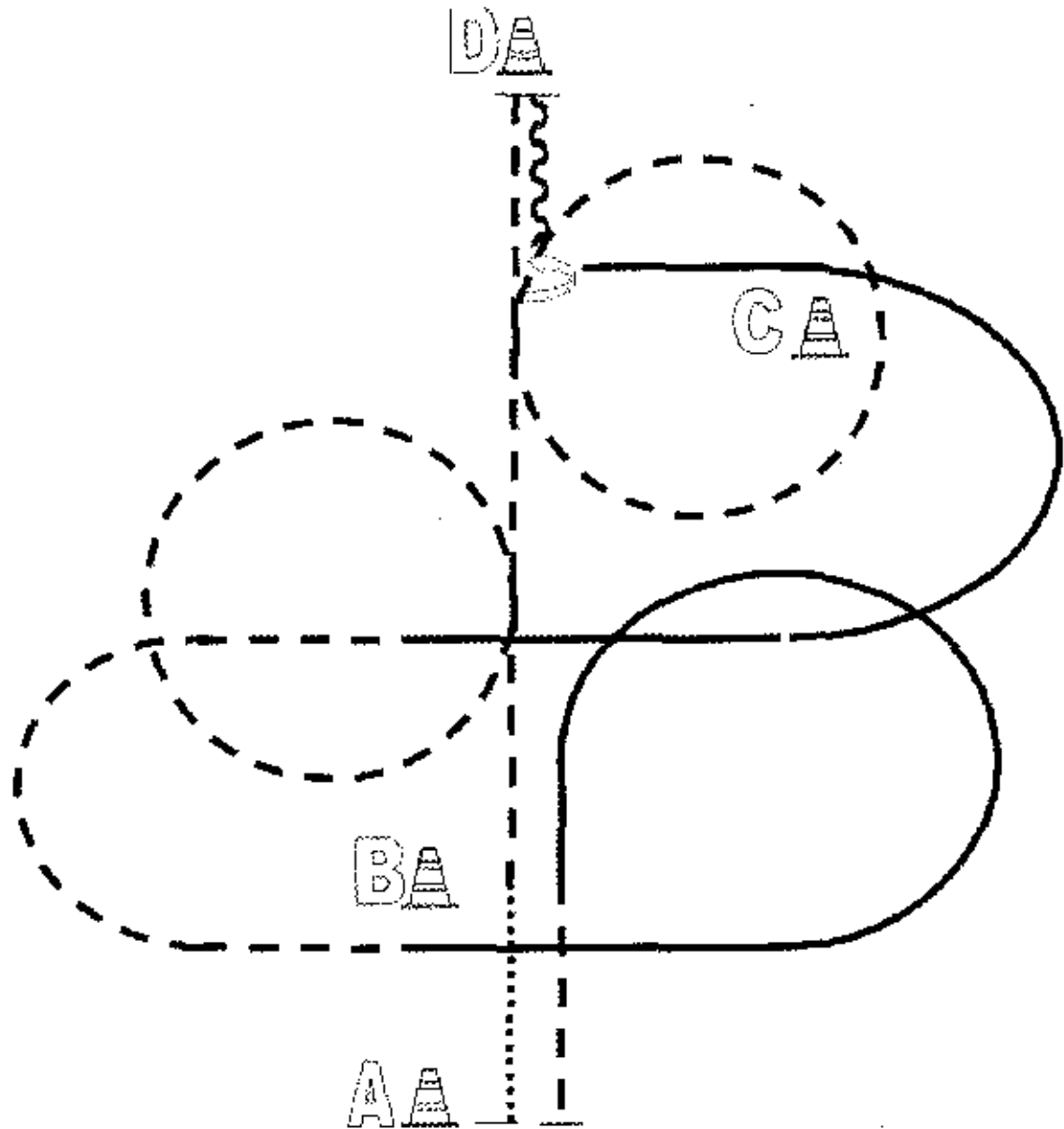

Giekau
03.-04.05.2014

Western Horsemanship LK 1/2



-  Back Up
-  Walk
-  Jog
-  Lope
-  Wechsel





1. Walk A-B, Jogvolte links, Jogvolte rechts, Stop, Back up
2. 270° HHW links, Lope rechts, ÜG Jog,
3. Lope links, Jog, Stop

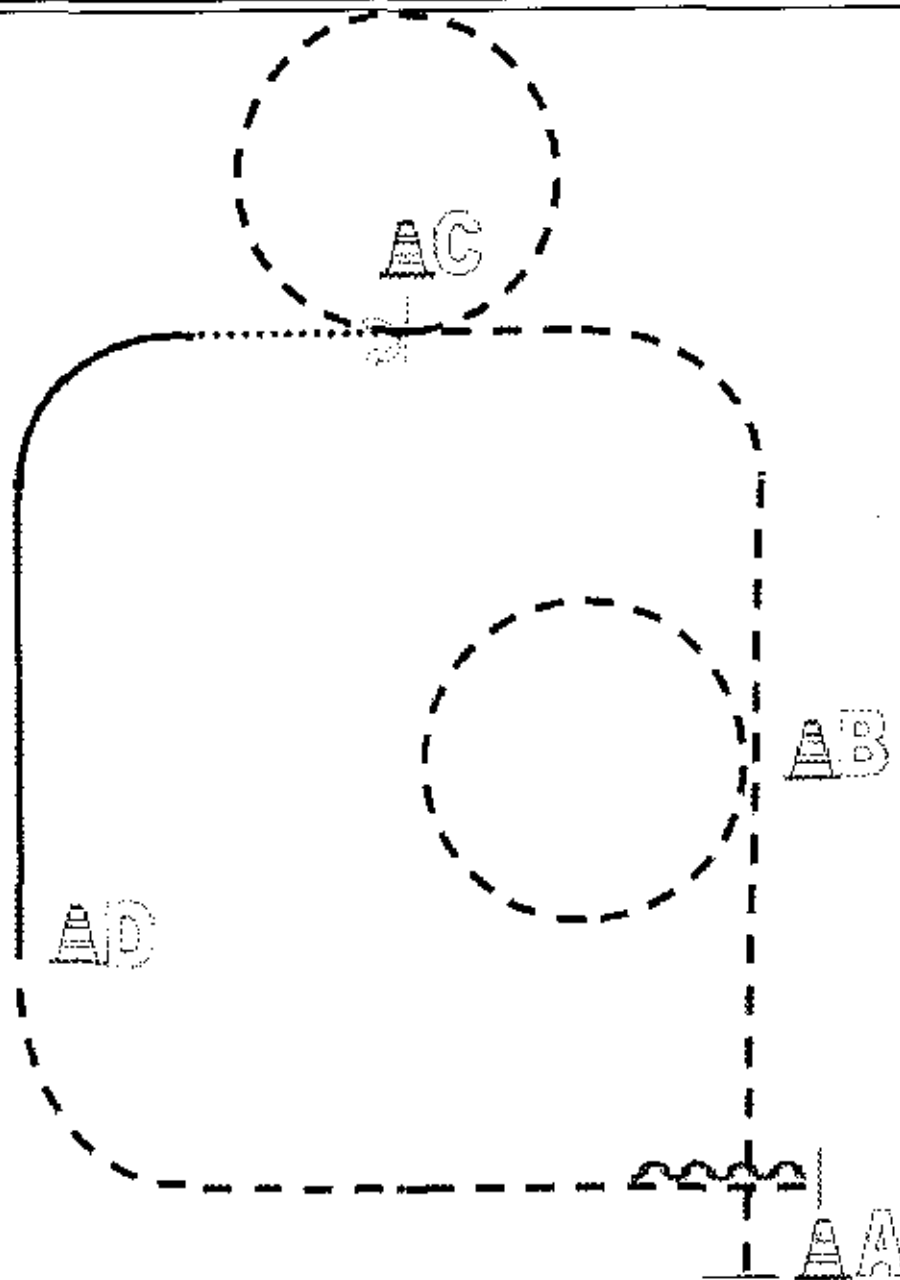

Giekau
03.-04.05.2014

Western Horsemanship LK 4 A/B



-  Back Up
-  Walk
-  Jog
-  Lope
-  Wechsel

1. Jog von A nach B, Jogvolte links, Jogvolte rechts um C
2. Stop, 360° HHW rechts, walk
3. Lope links, ÜG Jog, Stop, Back up



Giekau

03.-04.05.2014

Trail LK 5 A/B u. 4 B

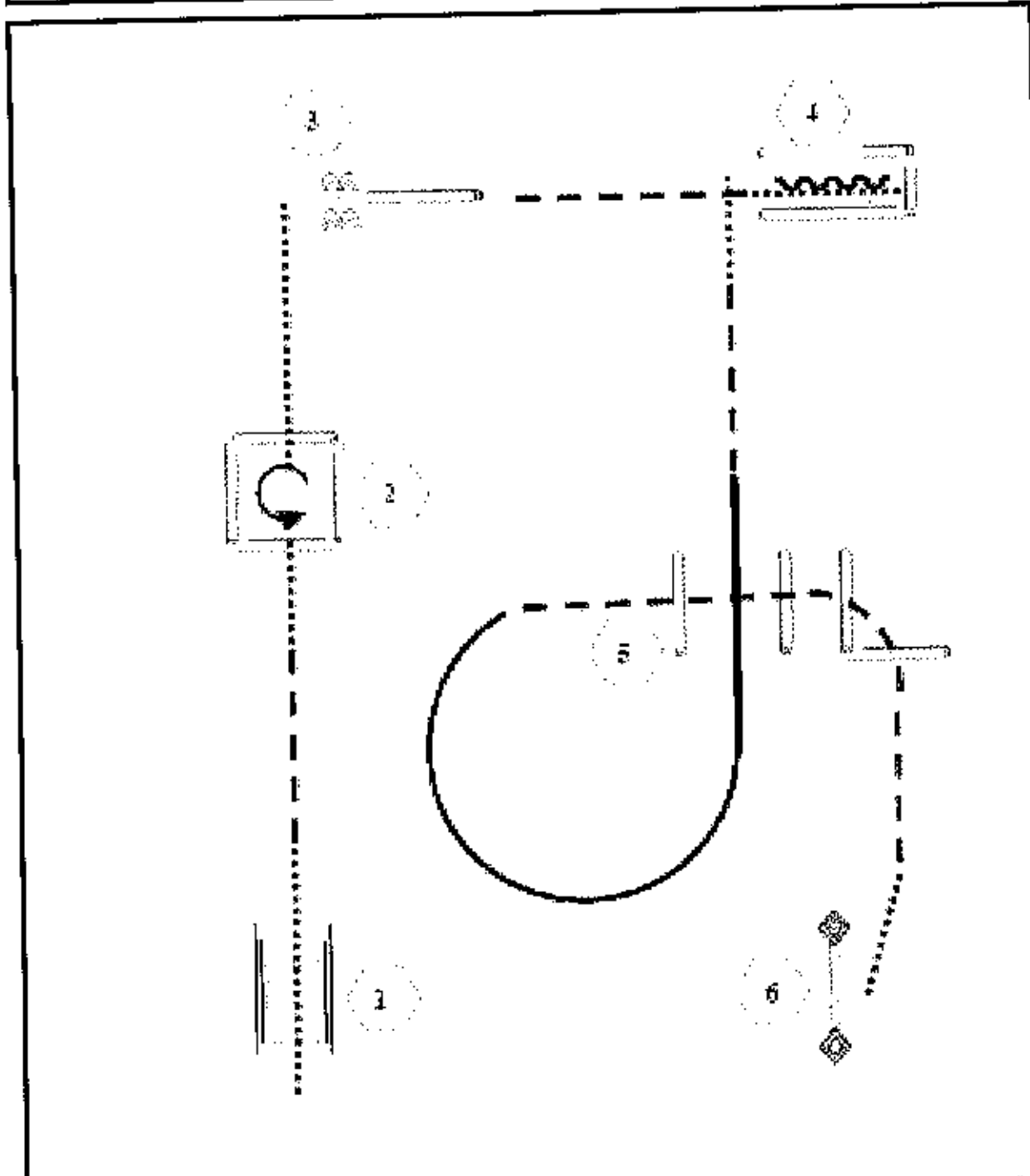





1. Rechteck		Back Up
2. Walk In. Box 360° Drehung links. Walk Out		Walk
3. Sidepass rechts		Jog
4. Walk In. Back Up		Lopa
5. Jog Out		Wechsel
6. Tier		Erbolung

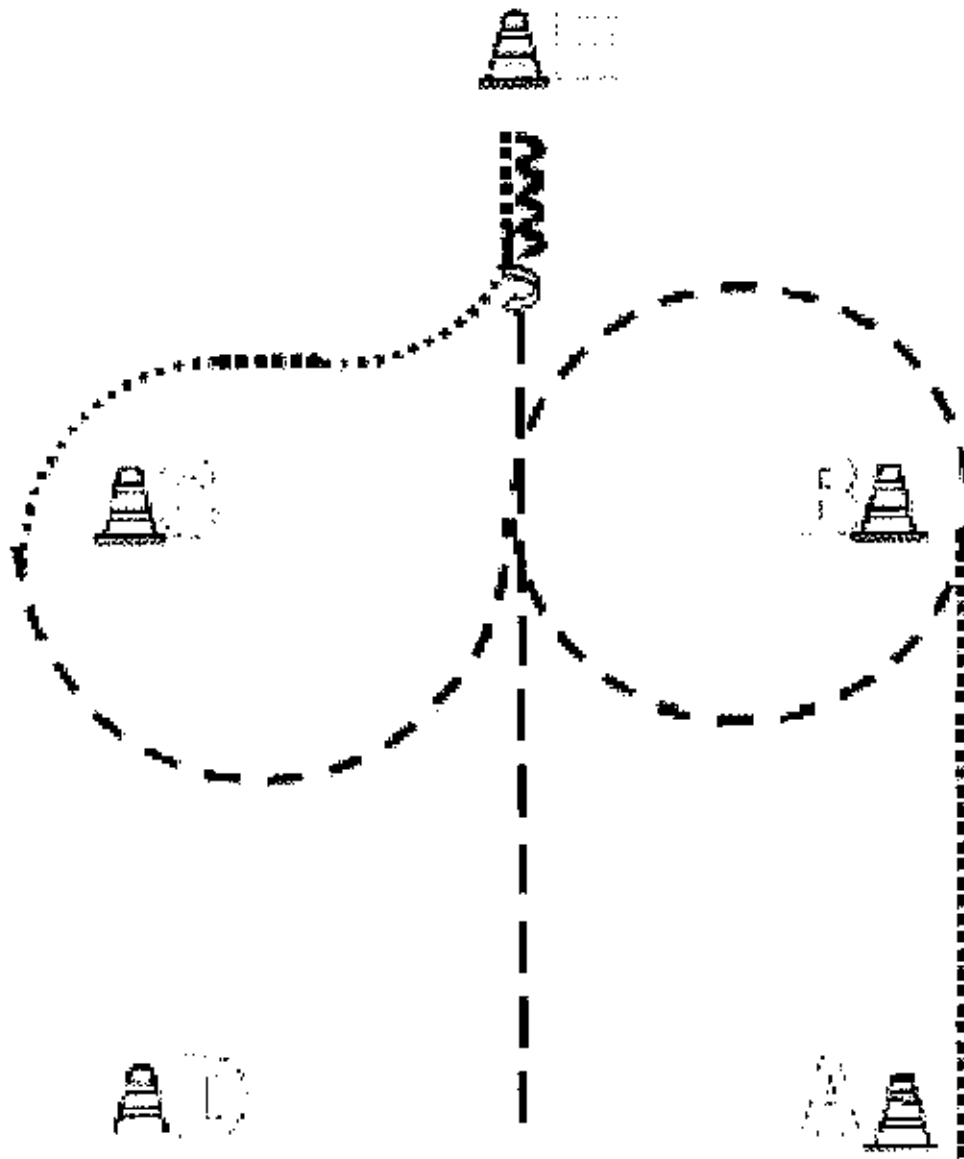

Giekau
03.-04.05.2014

SO WT Western Horsemanship



-  Back Up
-  Walk
-  Jog
-  Lope
-  Wechsel



1. Walk von A nach B, 1 ½ Jogvolten nach links
2. ½ Jogvolte nach rechts, Walk Stop
3. Back up, 180° HHW nach rechts Jog

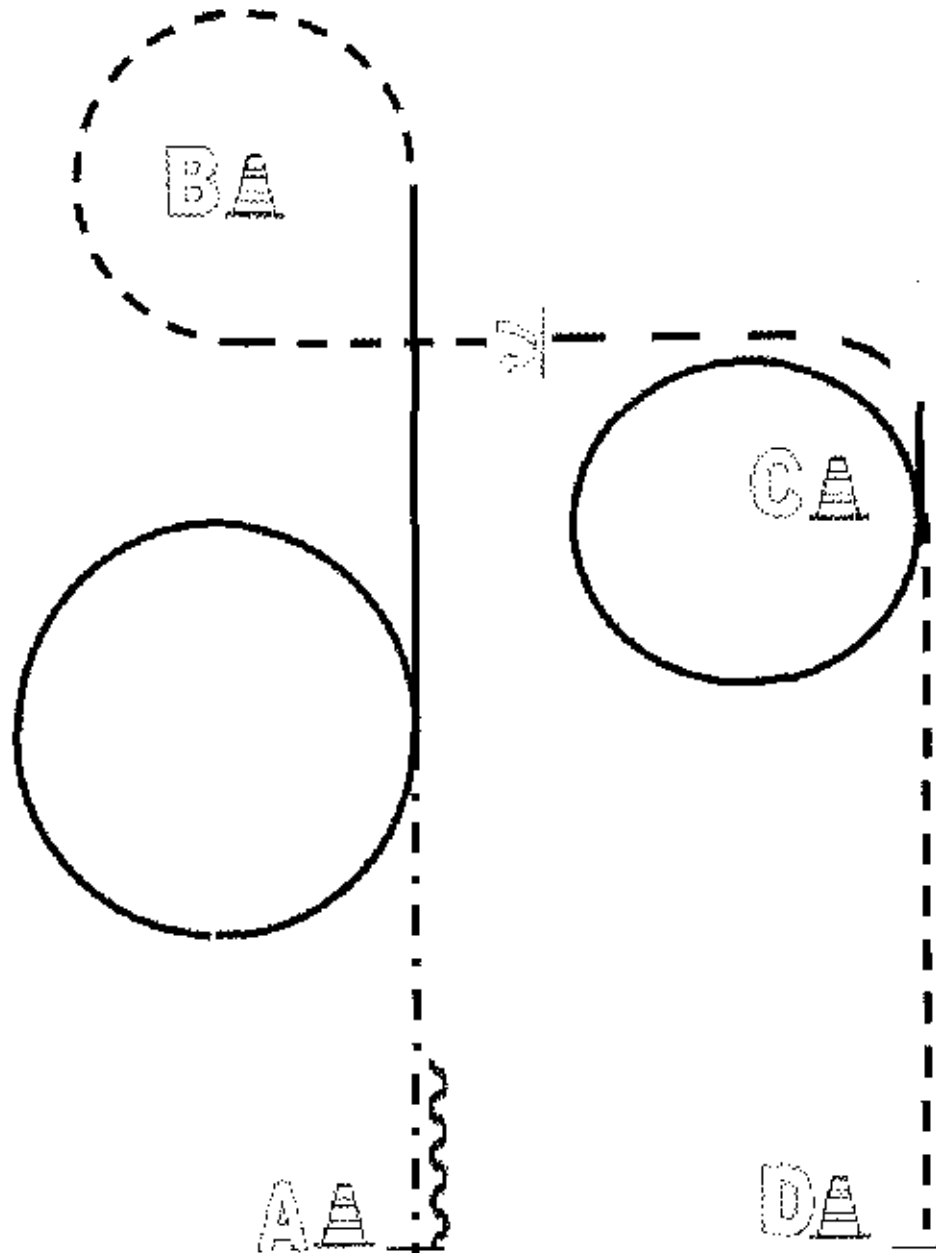

Giekau
03.-04.05.2014

Western Horsemanship LK 3 A/B

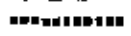

-  Back Up
-  Walk
-  Jog
-  Lope
-  Wechsel





1. Beginn bei D! Jog, Lopevolte links um C, Jog zwischen C und B anhalten, 360° HHW rechts
2. Jogvolte um B, Lope, Lopevolte rechts
3. Extended Jog bis A, Stop, Back up

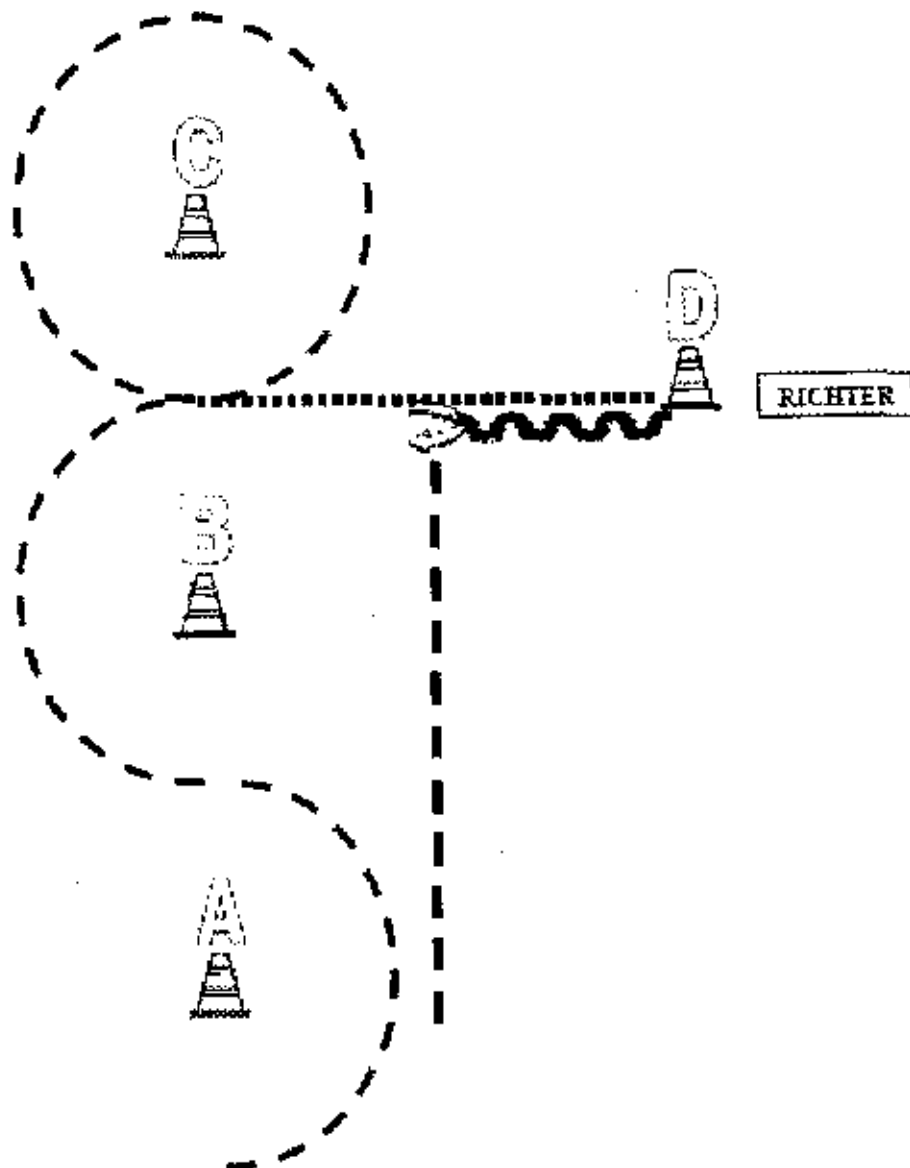

Giekau
03./04.05.2014

Showmanship LK 1/2 A/B



-  Back Up
-  Walk
-  Jog
-  Lope
-  Wechsel

- 1. Jog Slalom
- 2. Jog Volte
- 3. ÜG Walk, Stop
- 4. Set up
- 1. Back up Turn, Jog out



Giekau

03.-04.05.2014

Trail LK 4 A

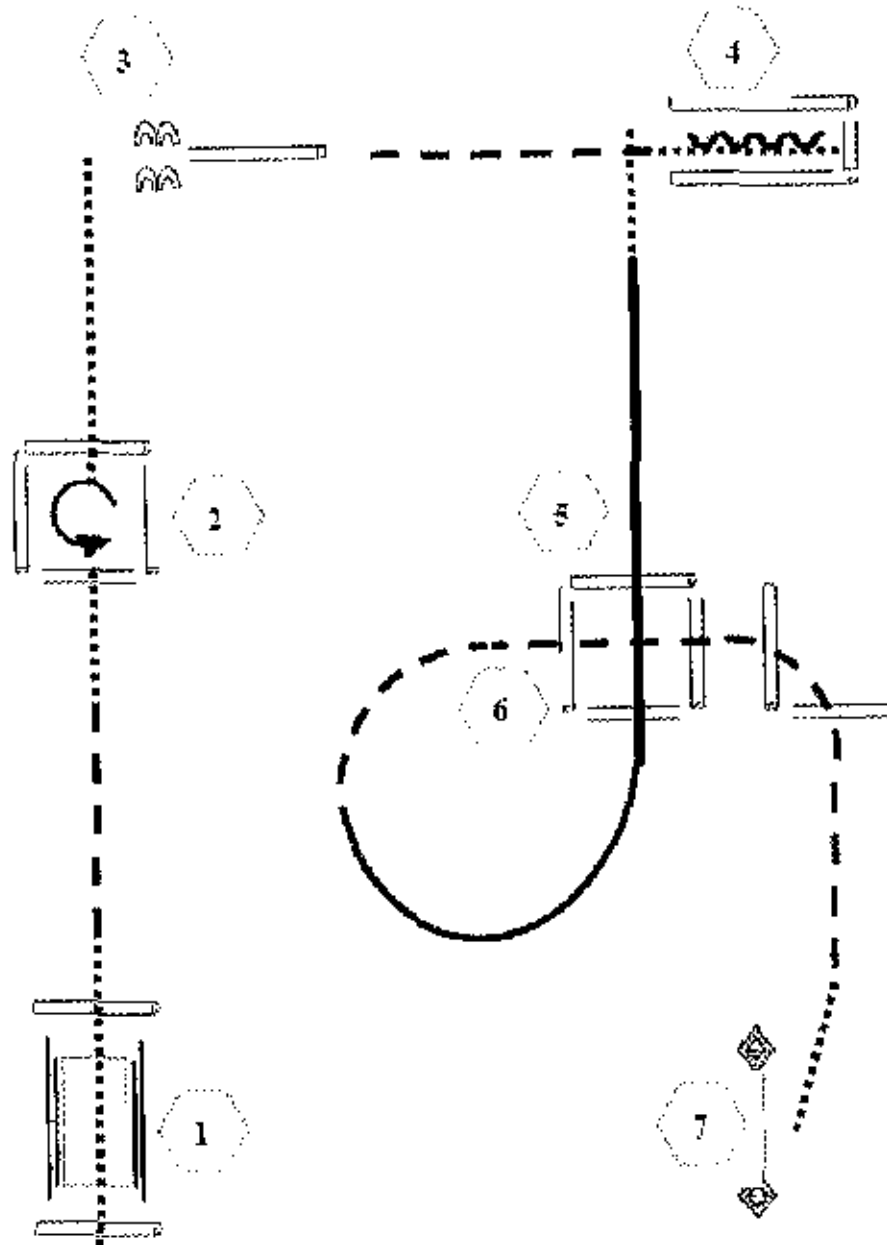

1. Brücke
2. Walk in Box 360° Drehung links, Walk Out
3. Sidepass rechts
4. Walk in, Back Up
5. Lope Over
6. Jog Over
7. Tor

	Back Up
	Walk
	Jog
	Lope
	Wechsel
	Erhöhung



Giekau

03.-04.05.2014

Trail LK 3 A/B

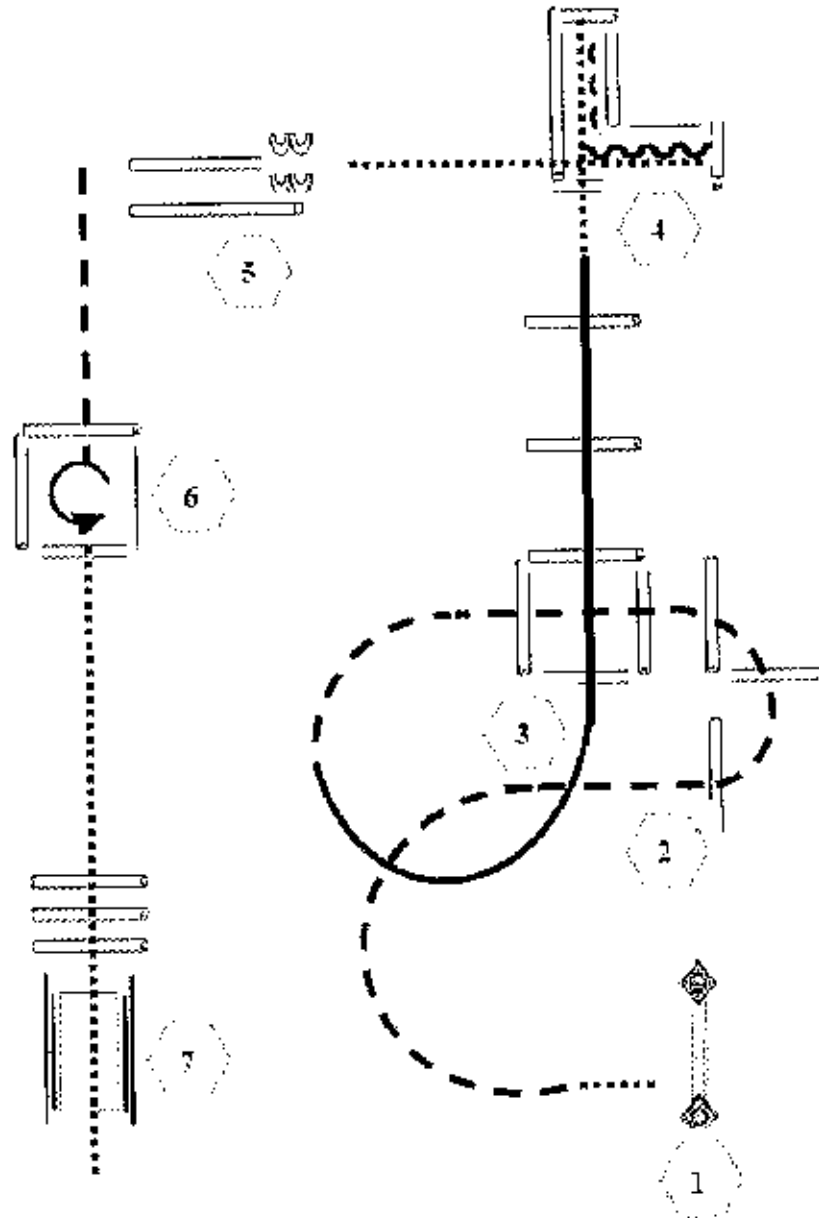

1. Tor
2. Jog Over
3. Lope Over
4. Walk In, Back Up, Walk Out
5. Sidepass rechts
6. Jog In, 360° Drehring links, Walks Out
7. Walk Over Brücke

	Back Up
	Walk
	Jog
	Lope
	Wechsel
	Erhöhung



Giekau

03.-04.05.2014

Trail LK 1/2 B

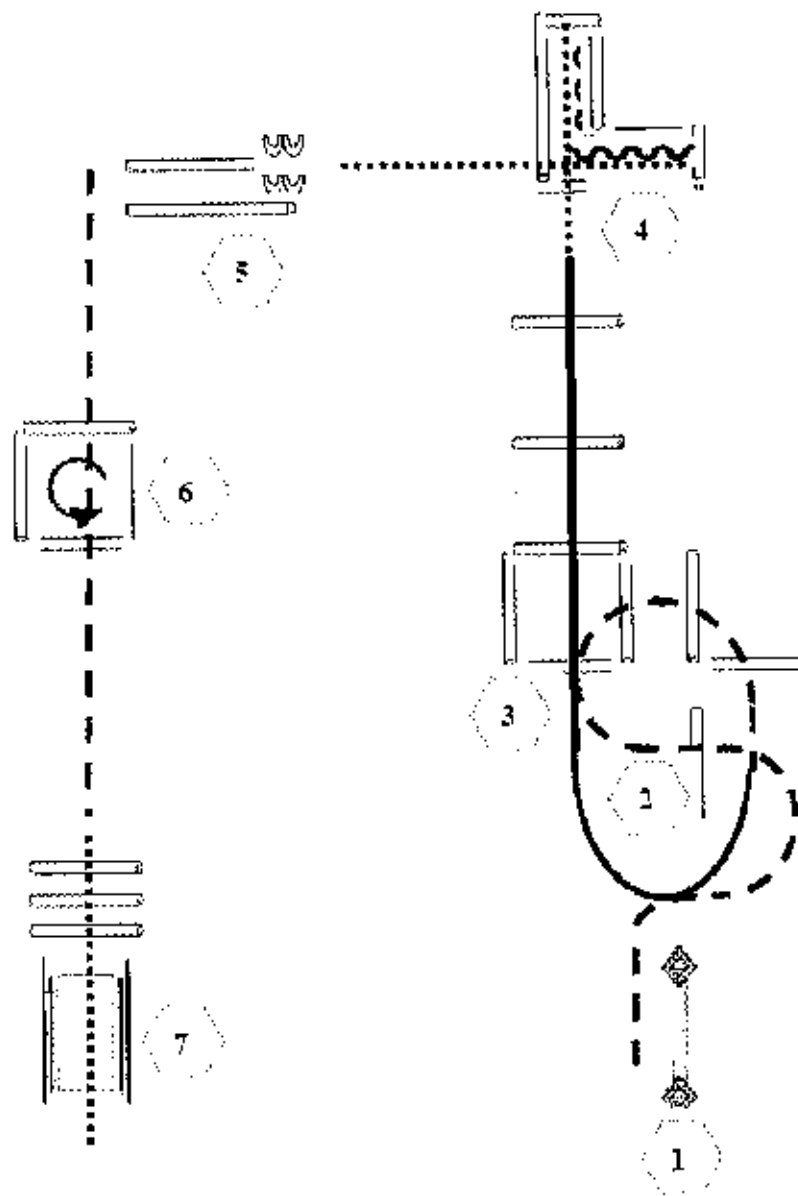

1. Trab
2. Jog Over
3. Lope Over
4. Walk In, Back Up, Walk Out
5. Sidepass rechts
6. Jog In, 360° Drehung links, Jog Out
7. Walk Over, Brücke

	Back Up
	Walk
	Jog
	Lope
	Wechsel
	Erhöhung



Giekau

03.-04.05.2014

Trail LK 1/2 A

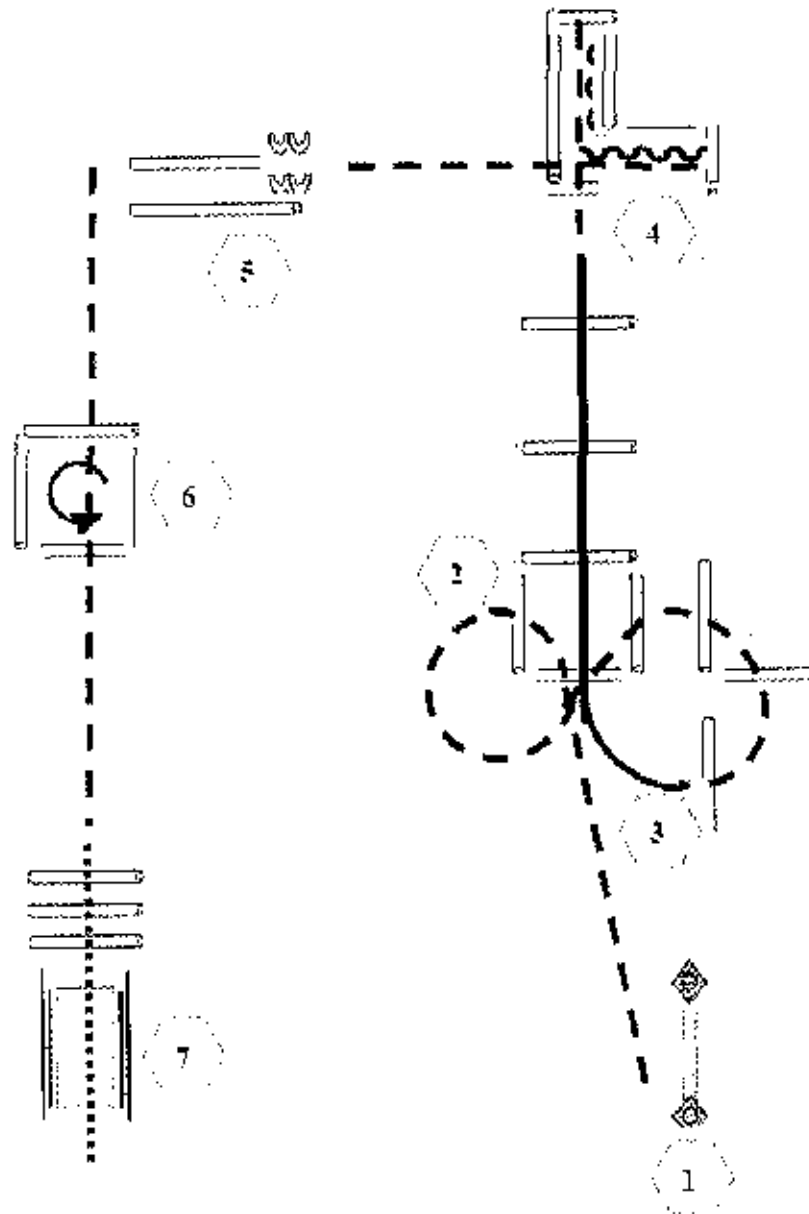

1. To:
2. Jog Out
3. Lope Over
4. Jog In, Back Up, Jog Out
5. Sidepass rechts
6. Jog In, 360° Drehung links, Jog Out
7. Walk Over: Brücke





	Back Up
	Walk
	Jog
	Lope
	Wechsel
	Erhöhung

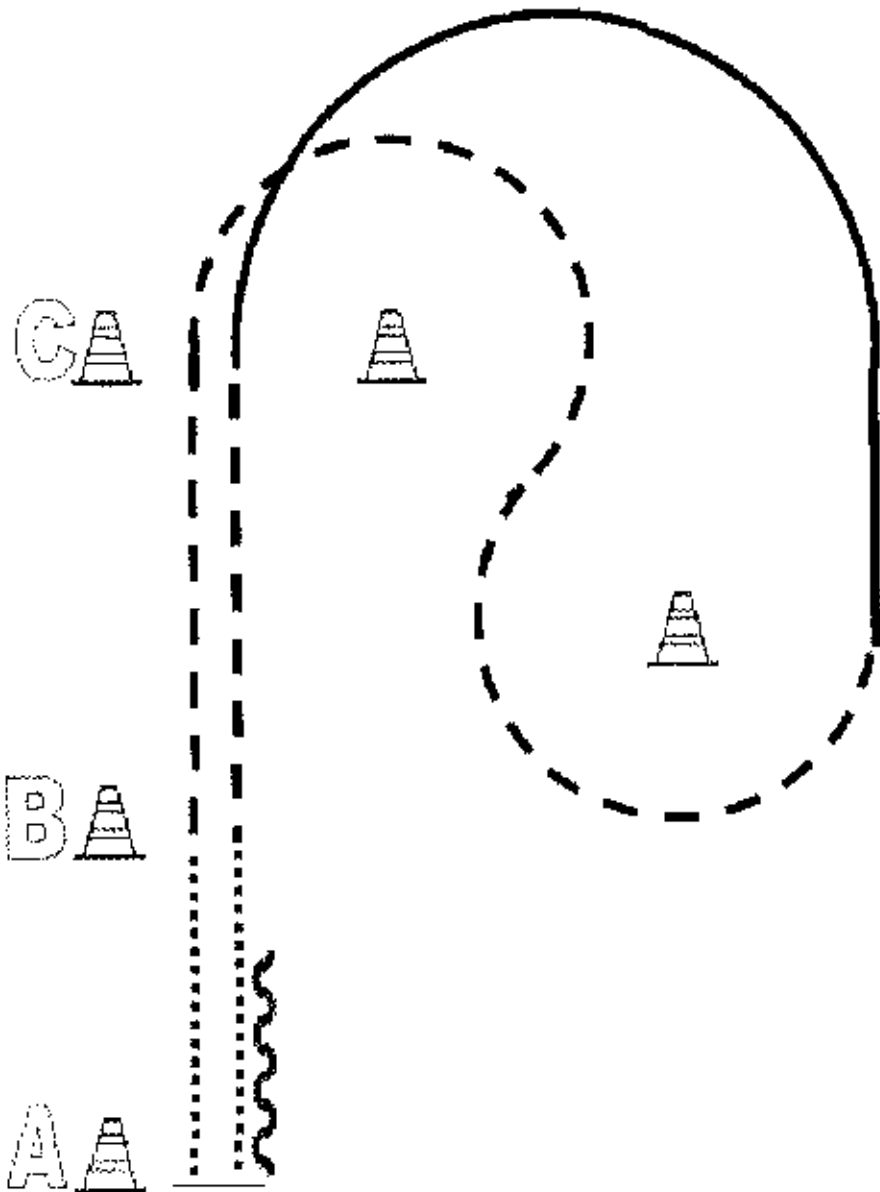

Giekau
03.-04.05.2014

Western Horsemanship LK 5 A/B

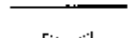

-  Back Up
-  Walk
-  Jog
-  Lope
-  Wechsel

1. Walk A-B, Jog Slalom
2. Lope links, ÜG Jog
3. Jog, Walk, Stop Back

RANCH PLEASURE – PATTERN I

1. Walk
2. Jog
3. Extend the jog ,at the top of the arena ,stop
4. 360 turn to the left
5. Left lead 1/2 circle, lope to the center
6. Change leads (simple or flying)
7. Right lead 1/2 circle
8. Extended lope up the long side of the arena (right lead)
9. Collect back to a lope around the top of the arena and back to center
10. Break down to a jog
11. Walk over poles
12. Stop and back

